



**sarıkaya**  
PERFORES

[www.sarikayaperfores.com.tr](http://www.sarikayaperfores.com.tr)

**ÜRÜN KATALOĞU**  
**PRODUCT CATALOGUE**





## **Rulo Delikli Saç Üretiminde Lider Kuruluş**

Perforated Sheet Roll Leader in The Enterprise

## **Türkiye'nin En Kaliteli Delikli Saç'ını Üretiyoruz**

We Produce The Highest Quality Perforated Sheet of Turkey

## **İsteğe Bağlı Özel Perforeler Yapılır**

We Can Produce Perforated For Your Special Requests

Ürün Kodu / Product Code : **SP1**

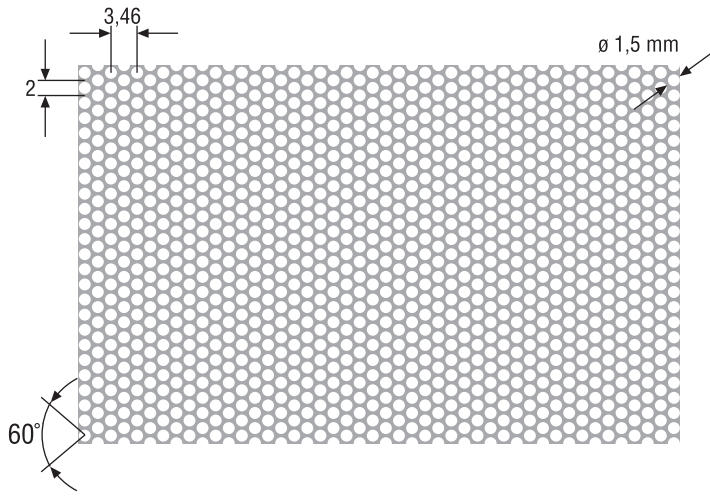

Max. Rulo Eni / Roll With: **430 mm**

Boşaltma Oranı / Open Area: **% 51**

Ürün Kodu / Product Code : **SP2**

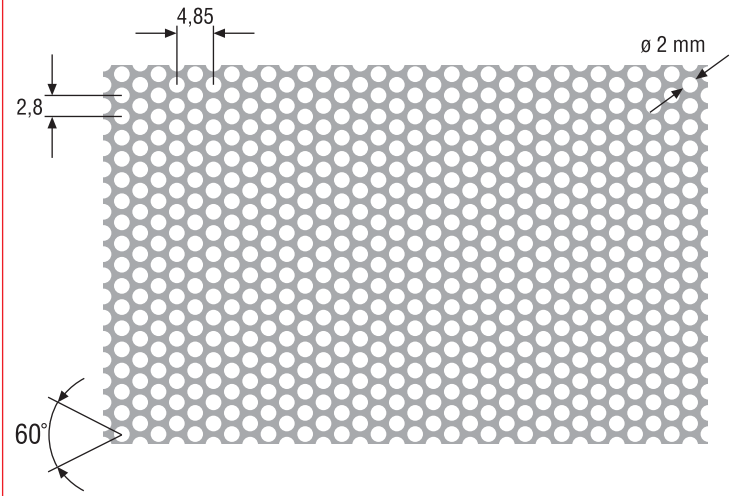

Max. Rulo Eni / Roll With: **430 mm**

Boşaltma Oranı / Open Area: **% 46**

Ürün Kodu / Product Code : **SP3**

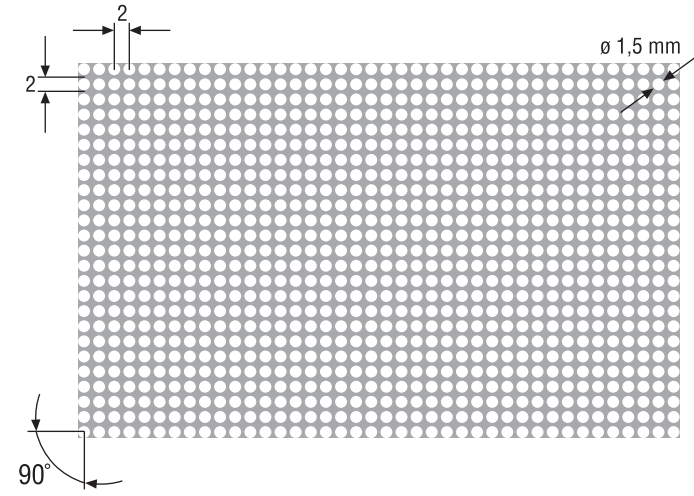

Max. Rulo Eni / Roll With: **350 mm**

Boşaltma Oranı / Open Area: **% 44**

Ürün Kodu / Product Code : **SP4**

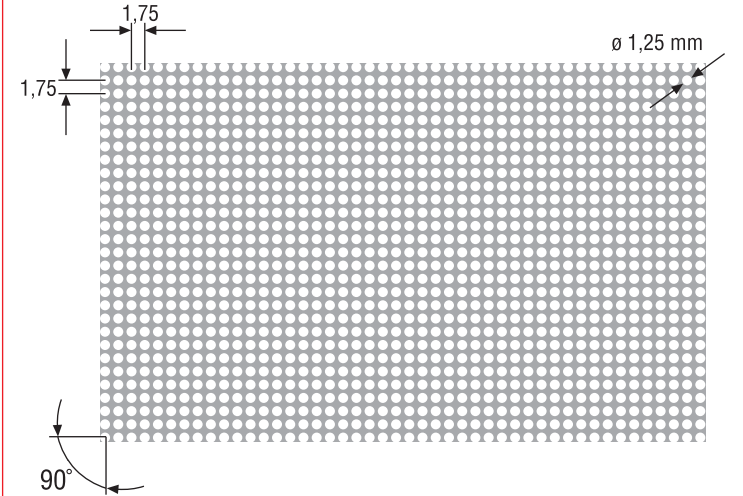

Max. Rulo Eni / Roll With: **650 mm**

Boşaltma Oranı / Open Area: **% 40**

Ürün Kodu / Product Code : **SP5**

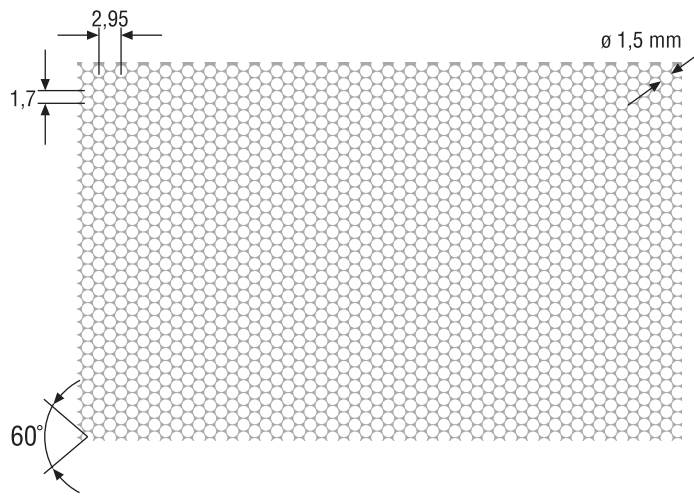

Max. Rulo Eni / Roll With: **430 mm**

Boşaltma Oranı / Open Area: **% 70**

Ürün Kodu / Product Code : **SP6**

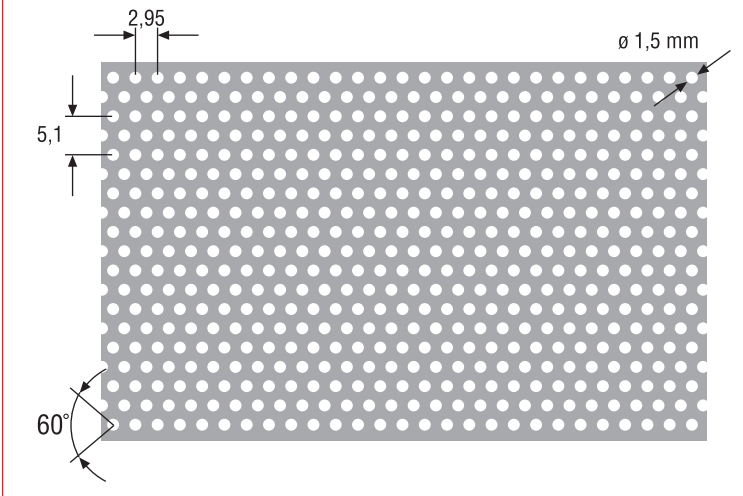

Max. Rulo Eni / Roll With: **430 mm**

Boşaltma Oranı / Open Area: **% 23**

Ürün Kodu / Product Code : **SP7**

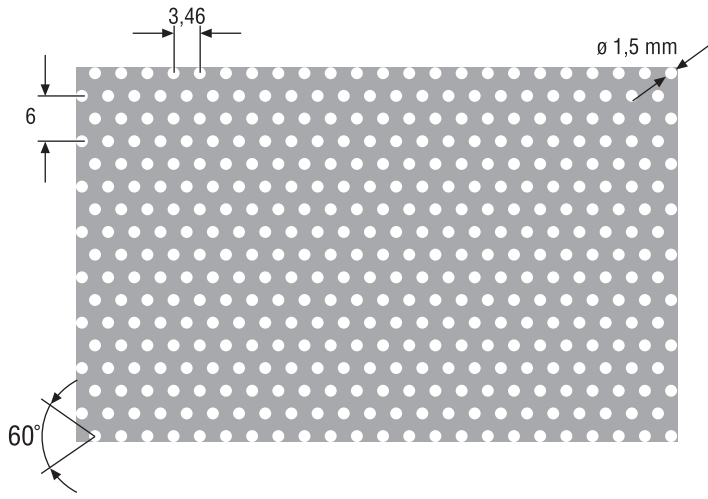

Max. Rulo Eni / Roll With: **430 mm**

Boşaltma Oranı / Open Area: **% 17**

Ürün Kodu / Product Code : **SP8**

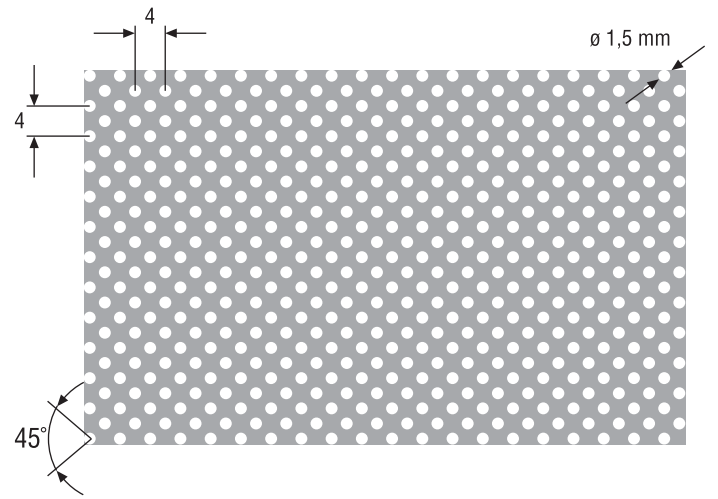

Max. Rulo Eni / Roll With: **350 mm**

Boşaltma Oranı / Open Area: **% 22**

Ürün Kodu / Product Code : **SP9**

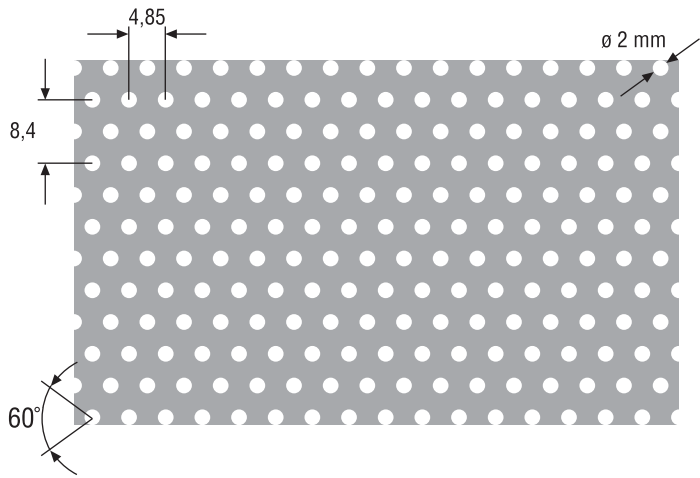

Max. Rulo Eni / Roll With: **430 mm**

Boşaltma Oranı / Open Area: **% 15**

Ürün Kodu / Product Code : **SP10**

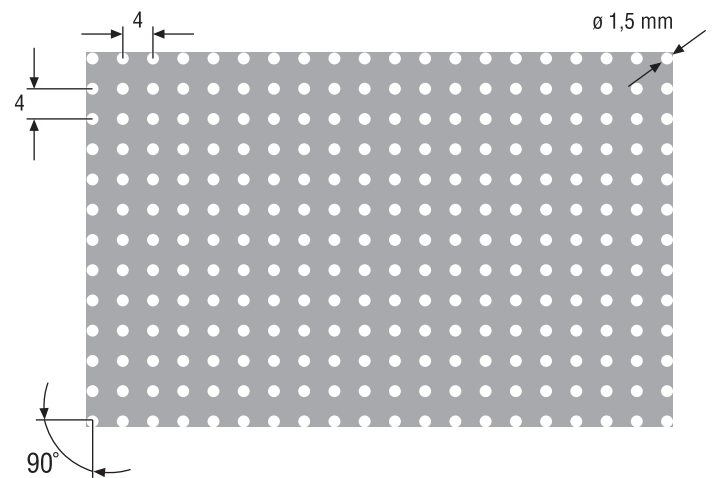

Max. Rulo Eni / Roll With: **650 mm**

Boşaltma Oranı / Open Area: **% 11**

Ürün Kodu / Product Code : **SP11**

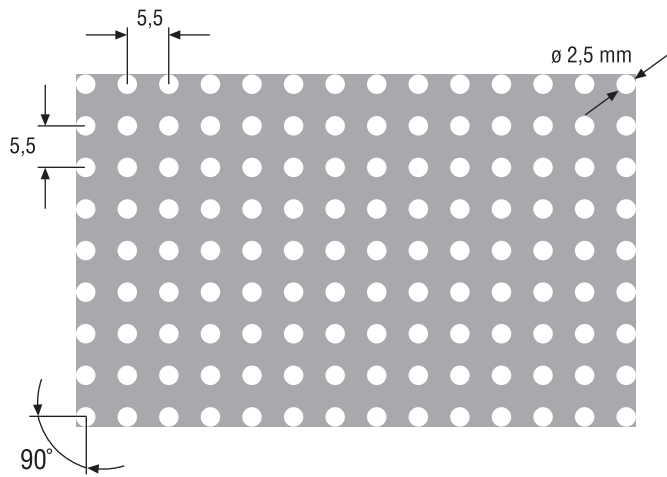

Max. Rulo Eni / Roll With: **1.250 mm**

Boşaltma Oranı / Open Area: **% 16**

Ürün Kodu / Product Code : **SP12**

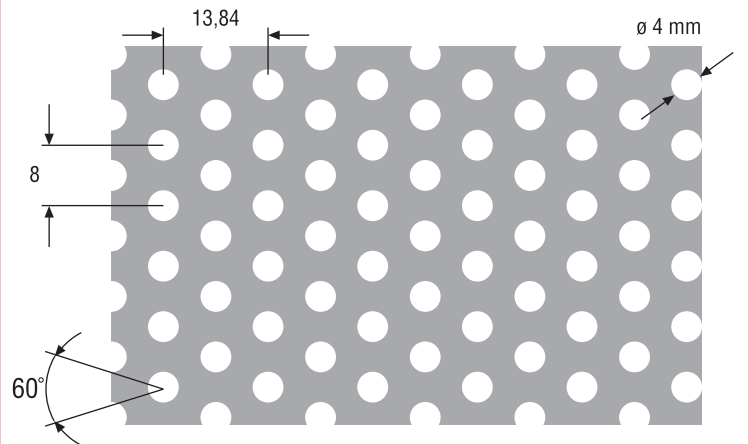

Max. Rulo Eni / Roll With: **1.250 mm**

Boşaltma Oranı / Open Area: **% 22**



Ürün Kodu / Product Code : **SP13**

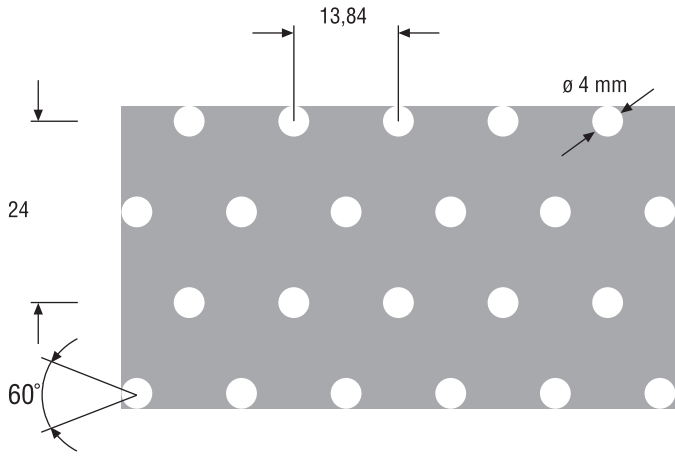

Max. Rulo Eni / Roll With: **1.250 mm**

Boşaltma Oranı / Open Area: **% 8**

Ürün Kodu / Product Code : **SP14**

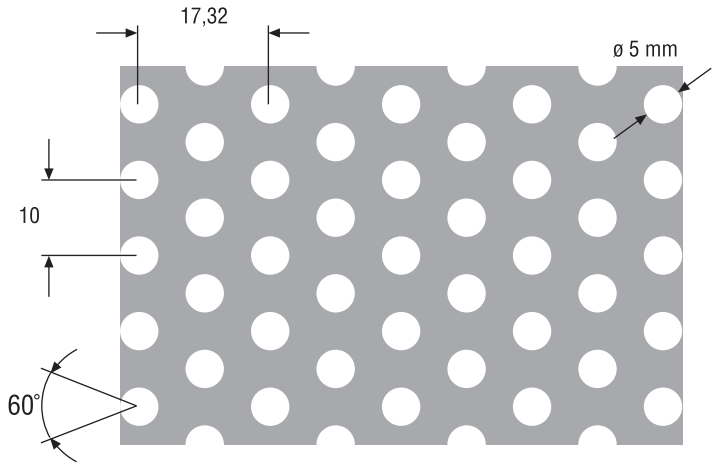

Max. Rulo Eni / Roll With: **1.250 mm**

Boşaltma Oranı / Open Area: **% 23**

Ürün Kodu / Product Code : **SP15**

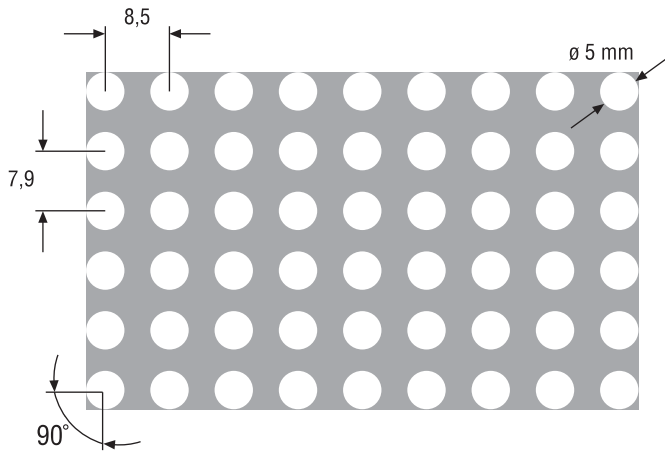

Max. Rulo Eni / Roll With: **1.250 mm**

Boşaltma Oranı / Open Area: **% 29**

Ürün Kodu / Product Code : **SP16**

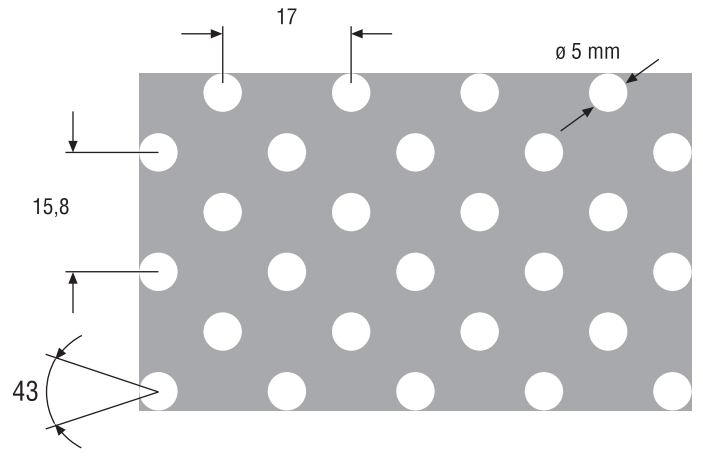

Max. Rulo Eni / Roll With: **1.250 mm**

Boşaltma Oranı / Open Area: **% 15**

Ürün Kodu / Product Code : **SP17**

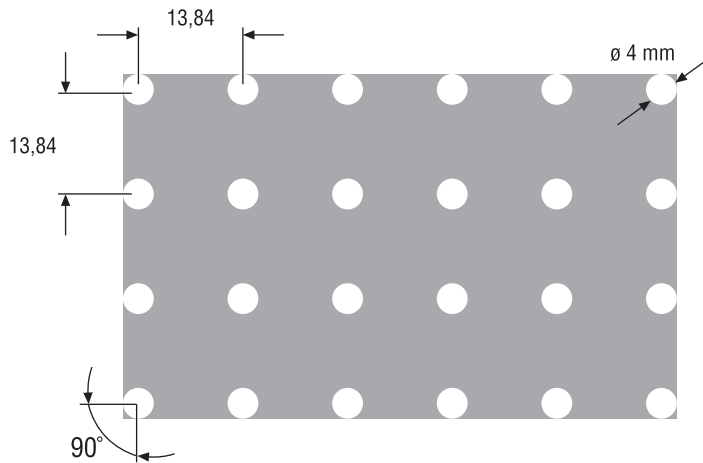

Max. Rulo Eni / Roll With: **1.250 mm**

Boşaltma Oranı / Open Area: **% 7**

Ürün Kodu / Product Code : **SP18**

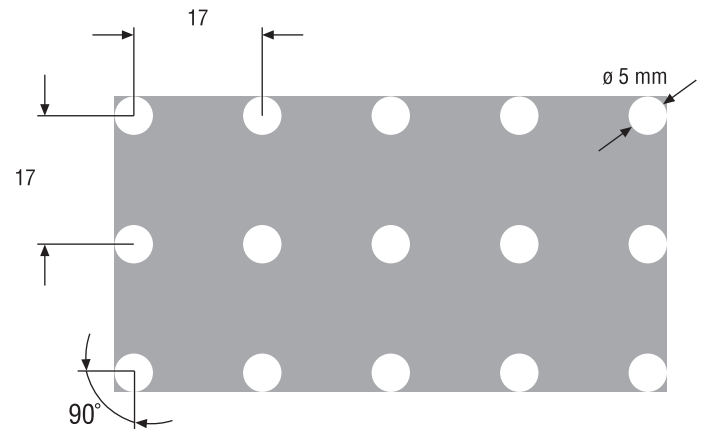

Max. Rulo Eni / Roll With: **1.250 mm**

Boşaltma Oranı / Open Area: **% 7**

Ürün Kodu / Product Code : **SP19**

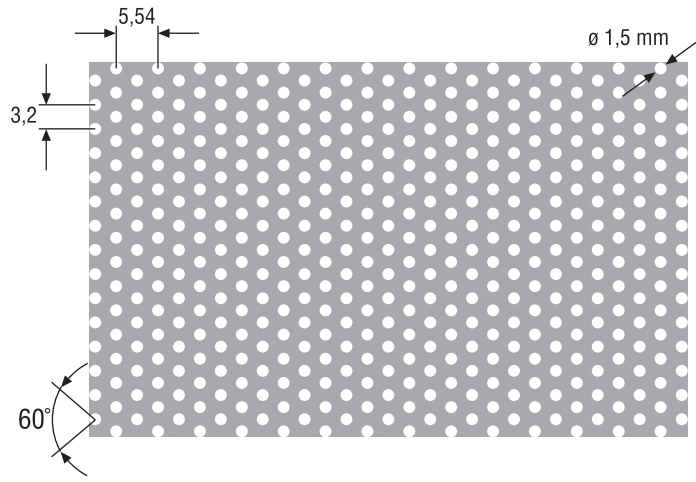

Max. Rulo Eni / Roll With: **1.250** mm

Boşaltma Oranı / Open Area: **% 20**

Ürün Kodu / Product Code : **SP20**

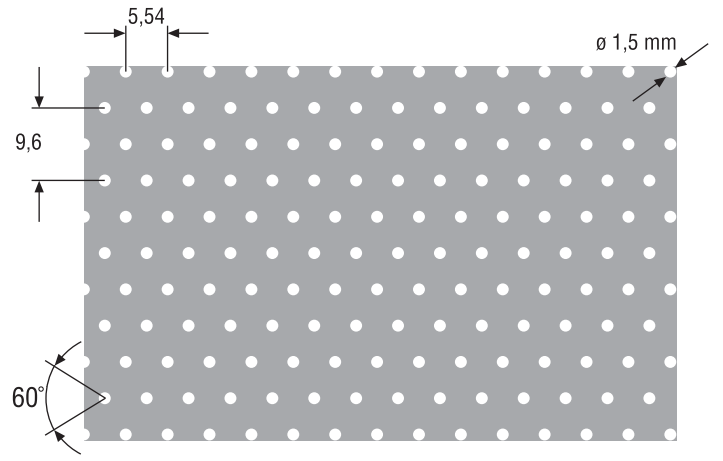

Max. Rulo Eni / Roll With: **1.250** mm

Boşaltma Oranı / Open Area: **% 7**

Ürün Kodu / Product Code : **SP21**

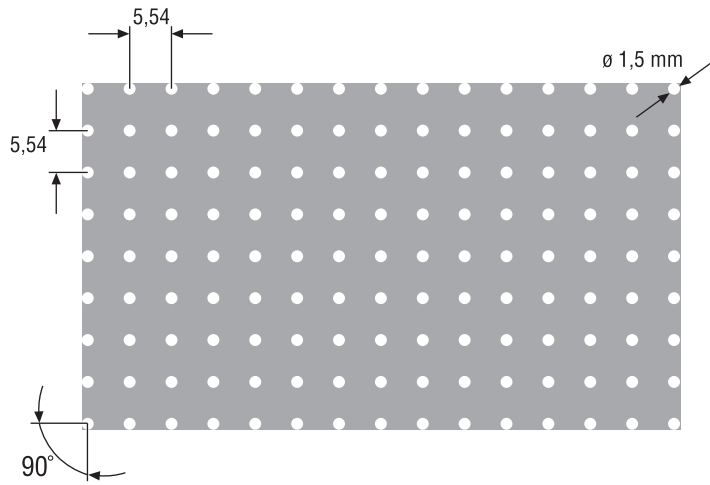

Max. Rulo Eni / Roll With: **1.250** mm

Boşaltma Oranı / Open Area: **% 6**

Ürün Kodu / Product Code : **SP22**

Max. Rulo Eni / Roll With:

Boşaltma Oranı / Open Area:

Ürün Kodu / Product Code : **SP23**

Max. Rulo Eni / Roll With:

Boşaltma Oranı / Open Area:

Ürün Kodu / Product Code : **SP24**

Max. Rulo Eni / Roll With:

Boşaltma Oranı / Open Area:





# CERTIFICATE

**56947**

This certificate was given to the below stated company by UDEM International Certification Audit Training Cent. Ind. Co. Ltd

**Sarıkaya Perfores Delikli Saç Gıda Alüminyum Elektronik Kalıp San. Tic. Ltd. Şti.**

İnönü Mah. Gebze Güzeller Organize Sanayi Bölgesi S.S.Galvano Kooperatifi  
Kazım Karabekir Sok. No:3/10 Gebze KOCAELİ/ TÜRKİYE

## ISO 9001:2008

Scope: Metal processing (manufacturing of perforated, ventilating grill), aluminium accesories

EA Code: 17

Certification Audit Date	: 20.06.2014
Decision Date	: 25.06.2014
Reissue Date	: -
Expiry Date	: 24.06.2015



UDEM International Certification  
Audit Training Cent. Ind. Co. Ltd.

Herby, UDEM International Certification Audit Training Cent. Ind. Co. Ltd, certifies that the above stated company have the appropriate management system according to the requirements of the above standard. This certificate is valid for 3 years since the decision date as long as the system is effectively maintained and surveillance audits are carried out. The validity of the certificate can be checked through [www.udemtd.com.tr](http://www.udemtd.com.tr) <http://www.jas-anz.com.au>. The certificate is the property of UDEM International Certification Audit Training Cent. Ind. Co. Ltd and shall be returned if requested.

Adres: Turan Güneş Bulvarı Karıman Sitesi 55/M Çankaya – Ankara – TÜRKİYE Tel: +90 312 443 03 90 (pbx) Faks: +90 312 443 03 76  
E-posta: [info@udemtd.com.tr](mailto:info@udemtd.com.tr) Web: [www.udemtd.com.tr](http://www.udemtd.com.tr)

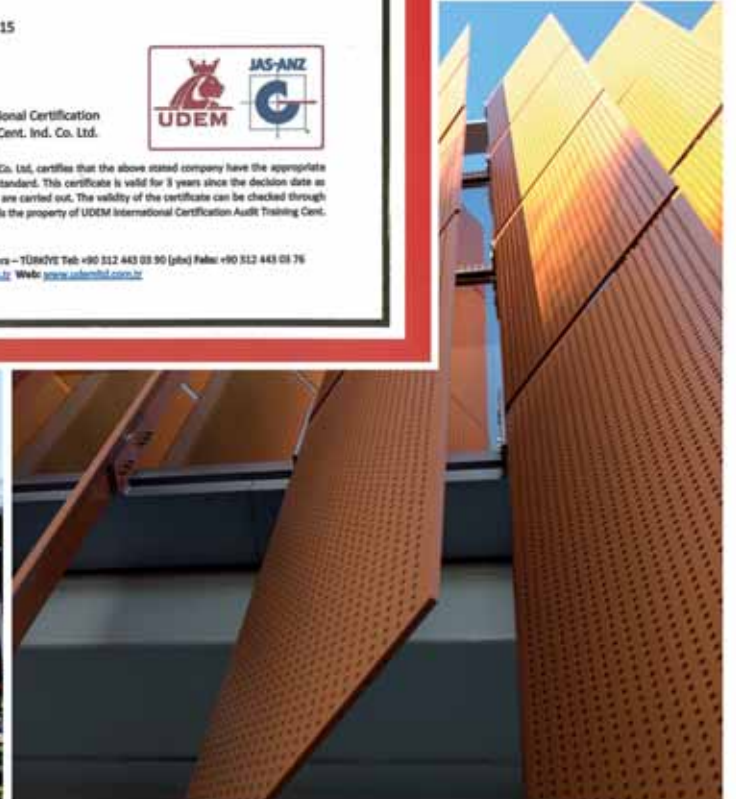
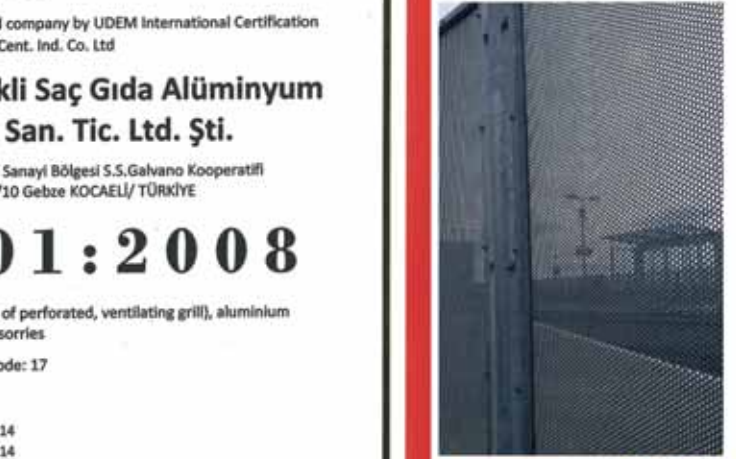





**sarikaya**  
**PERFORES**

**SARIKAYA PERFORES DELİKLİ SAÇ GIDA  
ALÜMİNYUM ELEKTRONİK KALIP SAN. TİC. LTD. ŞTİ.**

İnönü Mahallesi Güzeller Organize Sanayi Bölgesi  
S.S. Galvano Kooperatifi Kazım Karabekir Sokak  
No:3/10 Gebze / KOCAELİ  
Tel : +90 262 751 48 80 Fax : +90 262 751 48 81  
E-posta : info@sarikayaperfores.com.tr

[www.sarikayaperfores.com.tr](http://www.sarikayaperfores.com.tr)